

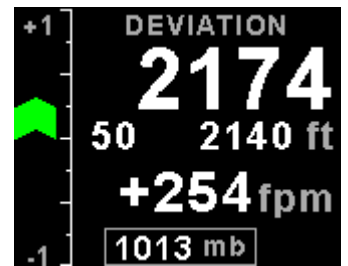

Vega ALT-5

Altimeter and Vertical Speed Indicator
with a transponder compatible serial
RS232 output

Operating Manual – English 1.13

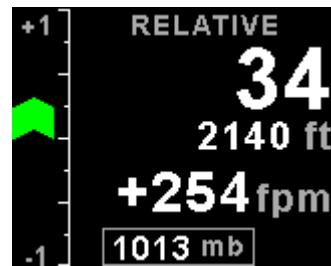
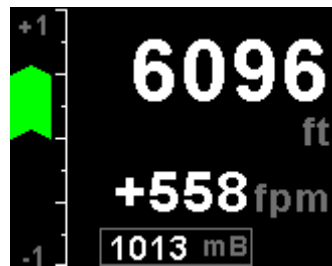

Introduction

The ALT-5 is a 2 1/4" (57mm) sunlight readable encoding altimeter and a wide range vertical speed indicator.

The altimeter contains an internal high accuracy 24 bit digital altitude sensor which calculates altitude from -1500 ft up to a maximum of +35000 ft. The ALT-5 outputs various formatted RS232 serial data protocols compatible with serial input transponders such as that from Garmin, Magellan, Northstar, Trimble, Microair etc. The altimeter can display altitude in feet or meters and local pressure can be set in millibars or inches of mercury

The VSI indicator can be displayed in either feet/minute (ft/min) or meters/second (m/s). The VSI can be calibrated by the user once the instrument has been installed in the aircraft.

The ALT-5 also features a user settable altitude bug and an encoder test function. The ALT-5 provides a parallel Gillham code interface when used in conjunction with the MGL Avionics CNV-ALT. The ALT-5 can also be used to measure relative or deviation altitude and it has a facility for the pilot to enter a reference altitude and deviation band.

1 Features

- Large 1.8" high resolution 160x128, wide viewing angle, sunlight readable, 1000 cd/m2 color LCD display
- An internal high accuracy 24 bit digital altitude sensor calculates altitude from -1500 ft up to a maximum of +35000 ft (-457m to 10668m)
- The ALT-5 outputs various formatted RS232 serial data protocols compatible with serial input transponders such as that from Garmin, Magellan, Northstar, Trimble, Microair etc.
- Provides a parallel Gillham code interface for transponders when used in combination with the MGL Avionics CNV-ALT
- Built in encoder test function
- The altimeter can display altitude in feet or meters
- Local pressure can be set in millibars or inches of mercury
- Contains a wide range VSI indicator from +/-20 ft/min to as high as +/-10000 ft/min
- VSI units can be in feet/minute (ft/min) or in meters/second (m/s)
- User settable altitude bug with deviation band / level alarm
- Standard 2 1/4" (57mm) aircraft enclosure (can be front or rear mounted)
- Rotary control plus 2 independent buttons for easy menu navigation and user input
- Wide input supply voltage range of 8 to 30V DC
- 1 year limited warranty

2 Layout



Sunlight readable color graphic display:

Backlight can be adjusted in the menu system

2 1/4" (57mm) enclosure.
Can be front or rear mounted

F1 / Up Button:

Menu system: Softkey button
Normal display: Enable/disable altitude bug

F2 / Down Button:

Menu system: Softkey button
Normal display: Altitude bug setting display

Rotary Control (Up/Down) & Enter Button:

Press the rotary control during the normal display screens to access the menu system. Rotate anti/clockwise for up/down menu scrolling. Rotate the rotary control during the normal display mode to adjust the local pressure. Local pressure can be set in either mB or in "Hg.

3 Main Displays

The ALT-5 has 4 different display screens. The main display screen can be selected in the “ALT SETUP” menu.

3.1 Altitude "TAPE" Display

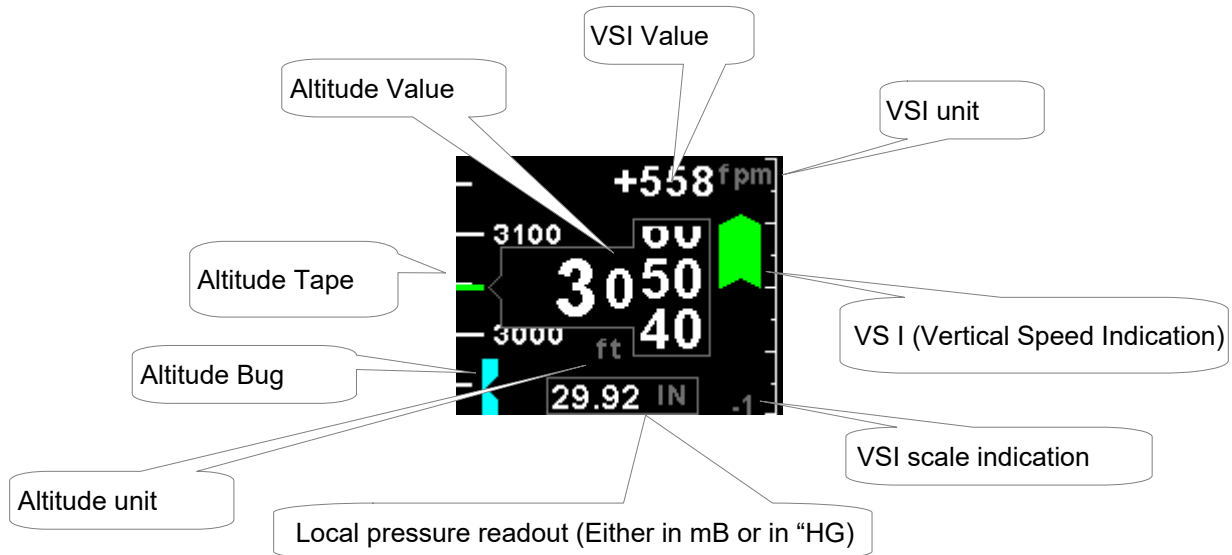

3.1.1 Altitude Bug



Press the F2/Down button during the altitude “TAPE” display to access the altitude bug setting screen. Press the F1/UP key to set the altitude bug to the current altitude or use the rotary control to adjust the altitude bug. Press the F2/Down key to change the increment / decrement unit to 50 or 500. Press the rotary control to exit and save.

Press the F1/Up button during the normal altitude “TAPE” display to enable or disable the altitude bug. The bug will be yellow when in the display screen and cyan when either above or below the limits of the display.

3.1.2 Deviation Band



Use the rotary control to adjust the altitude deviation band. Press the F2/Down key to change the increment / decrement unit to 50 or 100. Press the rotary control to exit and save.

The alarm output will activate if the current altitude is greater than the altitude bug plus the deviation band or less than the altitude bug minus the deviation band. The deviation band display is only shown if "DEVIATION" is selected for the alarm menu option.

3.2 Altitude "CLASSIC" Display

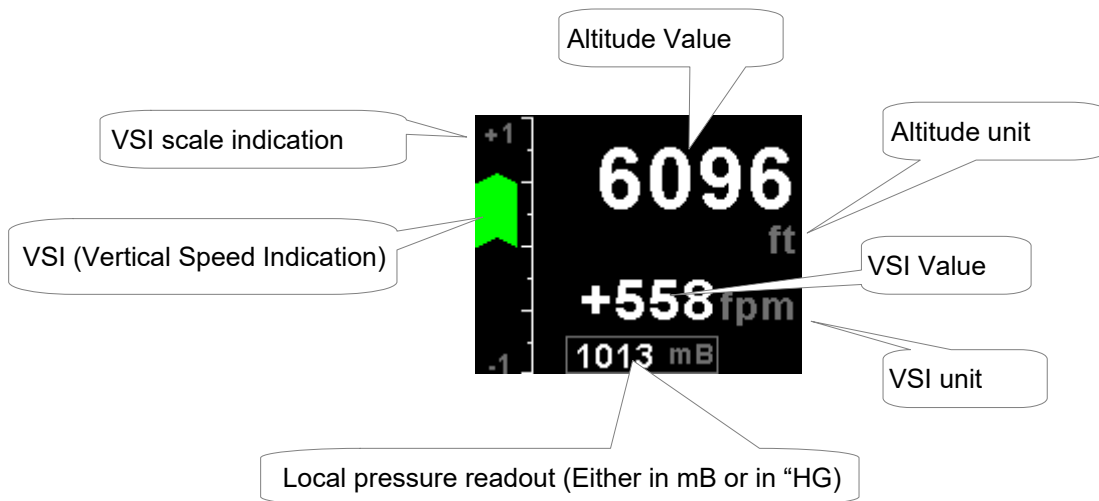

3.3 Relative Altitude Display

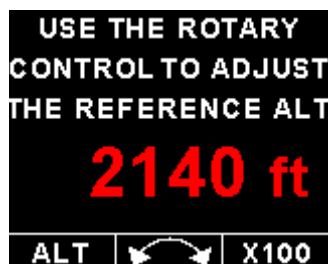
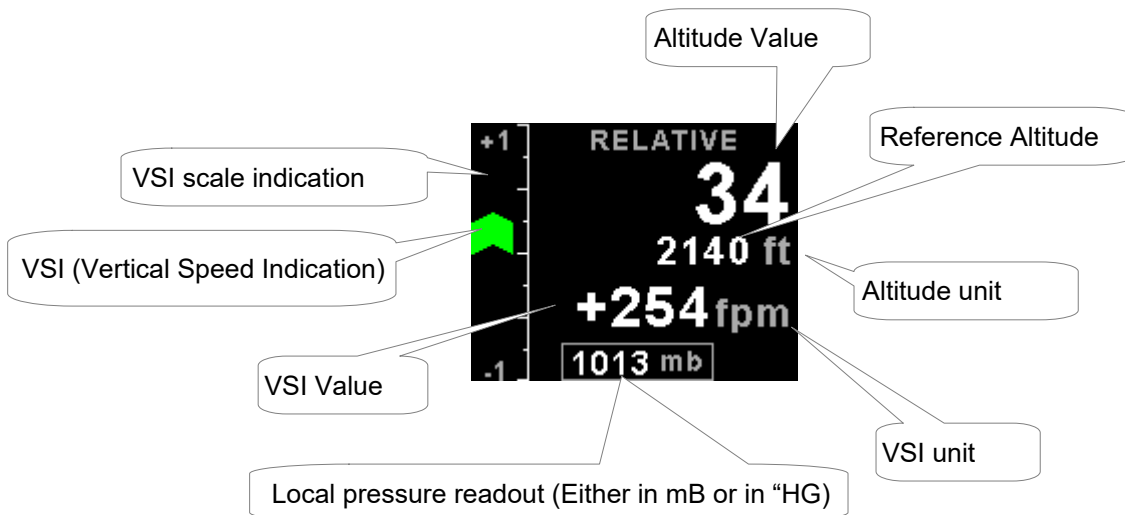

Press the F2/Down button during the Relative Altitude display to access the altitude reference screen. Press the F1/UP key to set the reference altitude to the current altitude or use the rotary control to adjust the reference altitude. Press the F2/Down key to change the increment / decrement unit to 10 or 100. Press the rotary control to exit and save.

3.4 Deviation Altitude Display

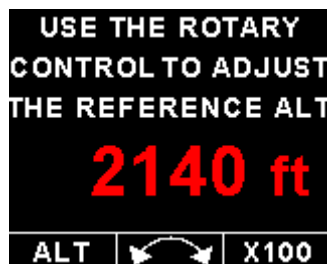
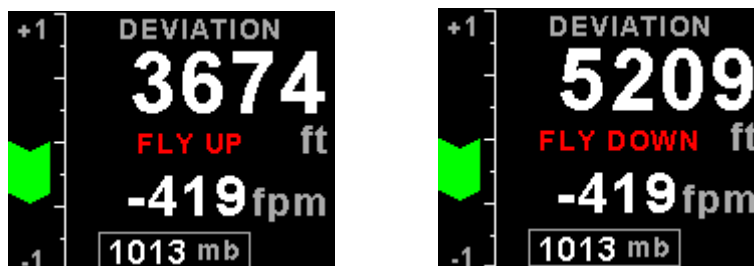
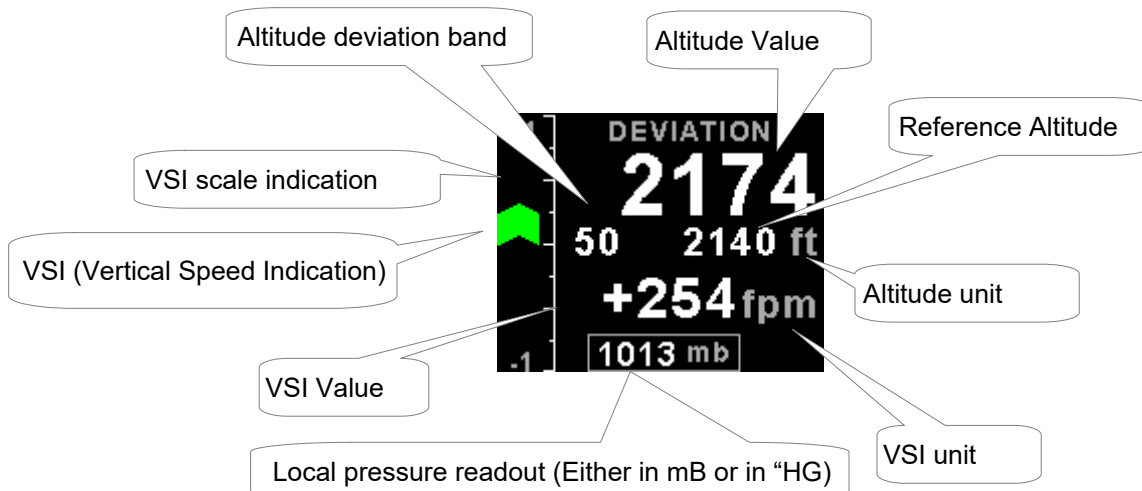

Press the F2/Down button during the Deviation Altitude display to access the altitude reference screen. Press the F1/UP key to set the reference altitude to the current altitude or use the rotary control to adjust the reference altitude. Press the F2/Down key to change the increment / decrement unit to 10 or 100. Press the rotary control to exit and save.



Use the rotary control to adjust the altitude deviation band. Press the F2/Down key to change the increment / decrement unit to 50 or 100. Press the rotary control to exit and save.

The alarm output will activate if the current altitude is greater than the reference altitude plus the deviation band or less than the reference altitude minus the deviation band.

4 Menu System

Press the rotary control button during the normal display mode to enter the menu system. Use the rotary control to navigate through the menu system.



4.1 Exiting the menu system

Press the F1/Up button to exit the menu system when the "EXIT" soft key is shown. All changes made during navigation of the menu system will be saved in non-volatile memory upon exiting. The instrument will not save any changes if you remove power before exiting the menu system.

4.2 ALT Setup (Altitude Setup)



Style:

Select the altitude display screen. Options include "TAPE" or "CLASSIC".

Altitude Unit:

Select if you want the altitude displayed in ft (feet) or m (meters).

Pressure Unit:

Select if you want the local pressure displayed in mb (millibars) or "Hg (inches of mercury).

Resolution:

Select the resolution of the altitude value, a selection of 1,10,25 or 100 ft or m can be selected.

Alarm:

Select "DEVIATION" if you want the alarm to activate if the altitude exceeds the deviation limit band around the altitude bug, or "LEVEL" if you want the alarm to activate if the altitude exceeds the altitude bug.

ALT Calibrate

This section allows for the calibration and fine tweaking of the altitude value. Before you begin, ensure that your calibrated and certified reference is set to the local pressure of 1013.25mB (29.92"Hg). The ALT-5 altitude value in ft (referenced to 1013.25mB (29.92"Hg)) is displayed in the top right hand corner of the display. All calibration must be done in feet.

The combined adjustments cater for both the altitude sensors offset and gain. Only start the calibration sequence once the instrument has been running for a minimum of 10 minutes.

Start the altitude calibration with the "CAL FACTOR" and make sure the "CAL GAIN" value is set to 100.00%.



Cal Factor:

This is the pressure sensor offset in 0.1mB increments. Adjust your static pressure to be close to sea level pressure. The exact altitude is not important and can be up to several hundred feet. Adjust the calibration factor so the altitude readout in the top right hand corner of the display agrees with your pitot static test set.

Cal Gain:

This menu item is only shown for certain pressure sensors. Once you are satisfied that the low level altitude “CAL FAC-TOR” is correct, apply a static pressure that will result in an altitude between 20000 and 30000 ft. Adjust the “CAL GAIN” until the altitude readout in the top right hand corner of the display agrees with your pitot static test set

NOTE: Adjusting the “CAL GAIN” also changes the low level altitude calibration achieved when adjusting the “CAL FAC-TOR”. Please recheck your low level altitude calibration and adjust if necessary. Recheck your altitude readout at the higher altitude, and if needed slightly adjust the “CAL GAIN” again. Repeat the process until you are satisfied with both the “CAL FACTOR” altitude and the “CAL GAIN” altitude.

Serial Out:

Select “ON” to enable the RS232 serial altitude output. This formatted serial RS232 message can be directly interfaced to various RS232 serial input transponders. If a parallel Gillham output is required then a CNV-ALT can be purchased from your MGL Avionics distributor to convert the RS232 output to a parallel Gillham output.

Prot:

Select the protocol of the serial RS232 output message. The protocol can be selected between GARMIN AT, Magellan, Northstar / Garmin, Trimble / Garmin, MGL Avionics and Microair UAV. Please note that the baud rate is automatically ad-justed according to which protocol is selected. The output format is as follows. The message contains the current pres-sure altitude with a fixed reference to 1013.25mB (29.92 inches mercury). All protocols use 8 databits, no parity, and 1 stop bit. The message is outputted once a second.

Protocol	Baud Rate	Message format	Example
Garmin AT	1200	#AL, space, +/-, five altitude digits right justified zero padded, T+25, checksum, carriage return The checksum is a simple modulo 256 sum of the binary values of the individual characters. The checksum is sent as two characters in hexadecimal format	#AL +02372T+25DF[CR]
Magellan	1200	#MGL, +/-, five altitude digits right justified zero padded, T+25, checksum, carriage re-turn The checksum is a simple modulo 256 sum of the binary values of the individual characters. The checksum is sent as two characters in hexadecimal format	\$MGL+02372T+2513[CR]

Northstar, Garmin	4800	ALT, space, five altitude digits right justified zero padded, carriage return	ALT 02372[CR]
Trimble, Garmin GTX327, GTX328, GTX330 (Set on Icarus)	9600	ALT, space, five altitude digits right justified zero padded, carriage return	ALT 02372[CR]
MGL Avionics	9600	ALT, +/-, five altitude digits right justified zero padded ,1013.25mB (29.92”Hg) referenced, C, +/-, five altitude digits right justified zero padded (corrected to local pressure), L, local pressure setting in millibars, +/-, four digit VSI reading right justified zero padded in ft/min, X, checksum, carriage return The checksum is a simple modulo 256 sum of the binary values of the individual characters. The checksum is sent as two characters in hexadecimal format	ALT+02372C+02372L1013+0000XCA[CR]
Microair UAV	9600	STX,a,=, five altitude digits right justified zero padded, ETX	[STX]a=02372[ETX]
Infiniteq	57600	See Infiniteq protocol format below	
STX=0x02 ETX=0x03 CR=0x0D			

Infiniteq protocol format:

STX, Address, Message type, Length, Data payload, Checksum, ETX

STX: Start of text (0x02)

Address: unsigned char (8bit), (0x01)

Message Type: unsigned char (8bit), (0x05)

Length: unsigned char (8bit), Length of the data payload (does not include the STX, Address, message type, checksum or ETX), (0x0c)

Data payload:

Altitude: Signed Long (32 bit), Altitude in feet (Referenced to 1013.25mB)

Altitude: Signed Long (32 bit), Altitude in feet (Corrected to local pressure)

Local Pressure: Unsigned Int (16 bit), Local pressure setting in millibars

Vertical Speed: Signed Int (16 bit), Vertical Speed in ft/min

Checksum: unsigned char (8bit), XOR of all bytes starting from the unit address to the end of the data payload. The checksum is seeded with 0xa5. (does not include the STX or ETX)

ETX: End of text (0x03)

Test Alt Encoder:

This is a handy function to test the ALT-5 transponder interface once the installation has been completed. The serial output will output specific altitudes which can then be used to test the serial RS232 output and the parallel gillham output if using a CNV-ALT converter. The ALT-5 will resume the normal output of the indicated altitude upon exiting the test function.

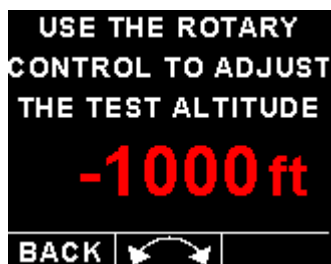

The following codes are outputted:

Altitude	D4	A1	A2	A4	B1	B2	B4	C1	C2	C4
-1000ft	0	0	0	0	0	0	0	0	1	0
-900ft	0	0	0	0	0	0	0	1	1	0
-700ft	0	0	0	0	0	0	1	1	0	0
-400ft	0	0	0	0	0	0	1	0	1	1
-200ft	0	0	0	0	0	1	1	0	0	1
800ft	0	0	0	0	1	1	0	0	0	1
2800ft	0	0	0	1	1	0	0	0	0	1
6800ft	0	0	1	1	0	0	0	0	0	1
14800ft	0	1	1	0	0	0	0	0	0	1
30800ft	1	1	0	0	0	0	0	0	0	1

Each altitude reporting code line must be tested for integrity of connection if at any time the aircraft connections to the transponder or altitude data source have been removed and reconnected. Integrity of the connections may be verified by performing a test of mode C function of the transponder system.

Warning: Do not use this function while in flight as incorrect altitude information will be sent to the transponder.

4.3 VSI Setup (Vertical Speed Indicator Setup)



VSI Display:

Select if you want the VSI display to be shown on the altitude "TAPE" display. The VSI display is always shown on the altitude "CLASSIC" display.

VSI Unit:

Select if you want the VSI to be displayed in "ft/min" (feet/minute) or "m/s" (meters/second).

Scale:

Select the VSI scale most suited for your aircraft.

VSI Cal:

This is a function that is used to calibrate your VSI to read exact rates of climb or decent. This function works as a percentage of initial reading. The default setting for this function is 100%. Increasing this value increases the VSI reading and decreasing the value decreases the reading.

Suggested VSI calibration method

After you have installed the instrument, perform a calibration flight. This should be done in very calm conditions. Turbulence and thermal activity will make accurate calibration impossible. Many areas have ideal conditions during early mornings or late afternoons. Place the instrument in ft/min for ease of calibration. Take your aircraft to a few thousand feet above ground and start a glide with a low power setting. Take a stopwatch and when the glide is stable (stable VSI reading) start the stopwatch. Take note of your altimeter reading at the same time. Continue the stable glide for one minute exactly. After the minute has finished, take another reading of your altimeter.

Example:

VSI reading during stable glide: -400 ft/min

Start altitude: 2500 ft.

End altitude: 2050 ft.

In the above example the VSI is under reading by about 12%. Set your VSI calibration to 112% to cancel out the error.

4.4 MISC Setup (Miscellaneous Setup)

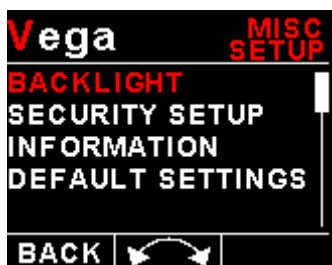

Backlight:

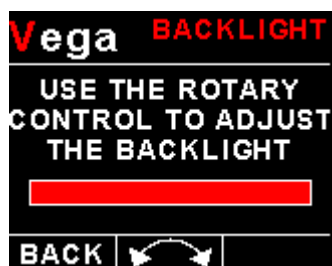

Select this menu option to adjust the backlight brightness.

Security Setup:



Select this menu option if you want to password protect the menu system.

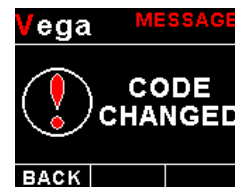
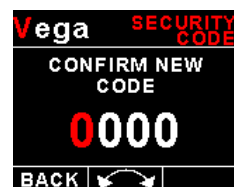
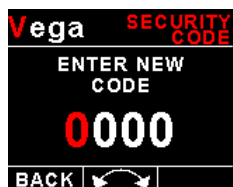
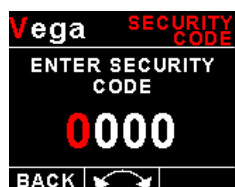

Information:



This menu option displays information about the unit.

Default Settings:

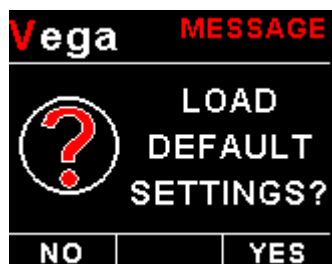

Select this menu option to reset all the settings to factory defaults.

5 Loading factory default settings

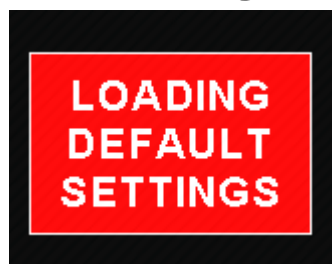

Press and hold the F1/Up button and rotary control during power up to load the pre-programmed factory default settings. The following screen will be displayed:

Factory default settings can also be loaded in the Miscellaneous setup menu.

6 Error Messages



Unit settings CRC error. Load default settings to restore to factory defaults. If the error message still persists then it could possibly be a non-volatile memory failure in which case the instrument will then have to be returned to the factory.



Calibration constants CRC error. The instrument could possibly have a non-volatile memory failure in which case the instrument will then have to be returned to the factory.



Internal flash CRC error. The instrument does a firmware check on the program when power is applied to the instrument . If the program is corrupt in any way then the internal flash CRC error will be displayed. Reload the instruments firmware and load default settings. If the error message still persists then it could possibly be an internal flash memory failure in which case the instrument will then have to be returned to the factory.

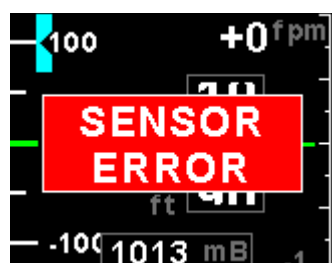

Altitude sensor error. The instrument could have a faulty altitude sensor in which case the instrument will then have to be returned to the factory.

7 Specifications

Operating Temperature Range	-20°C to 50°C (-4°F to 122°F)
Storage Temperature Range	-30°C to 80°C (-22°F to 176°F)
Power Supply	10 to 30Vdc
Current Consumption	Approx. 73mA @ 13.8V (backlight highest setting), 33mA @13.8V (backlight lowest setting)
Display	1.8" 160x128 color LCD display. 1000 cd/m ² Sunlight readable with anti-glare coating LED Backlight is user configurable
Alarm Output	Open collector transistor switch to ground Maximum rating 0.25A
Dimensions	see Vega series dimensional drawing
Enclosure	2 1/4" (57mm) ABS, black in color, front or rear mounting. Flame retardant.
Weight	Approx. 120 grams (Instrument excluding cables)
Non-volatile memory storage	100000 write cycles
Altitude sensor ADC resolution	24 bit
Altimeter range	-1500ft to +35000ft (-457m to +10668m)
Altitude units	ft or m
Baro Correction Range (inHg)	28.00 to 31.00 "Hg
Baro Correction Range (mB)	946 to 1050 mb
Pressure units	"Hg or mb
VSI range	+/-20ft/min to +/-10000ft/min
VSI units	ft/min or m/s
Serial Port	RS232 voltage levels
Calibration interval	1 Year

8 Operating the alarms

The alarm output can be used to switch an external alarm indicator. The external alarm switch is an open collector transistor switch to ground with a maximum rating of 0.25A DC. It is possible to wire the alarm contacts of several instruments in parallel should this be desired.

9 Firmware Upgrading

The ALT-5 can be upgraded in the field by connecting the RS232 port to a PC and running the firmware update program.

Note that only the RS232 port can be used to upgrade the firmware.

Please see the Vega firmware upgrading document for more information.

10 Installation

Connect the static port to a suitable static air pressure line. If you have a slow aircraft or an aircraft where the internal cabin pressure does not change during flight and is equivalent to the outside air pressure you may find that it is not required to connect a static port.

For installations in typical ultralight aircraft pods, be aware of possible pressure changes inside the pod during flight caused by ram air or suction effects. This may lead to a false indication of altitude. Often these effects are dependent on the current angle of attack of the airflow around your pod. You will need to install a suitable static port in these cases.

The ALT-5 static pressure port takes 4mm ID tubing. Use hose clamps to fasten the hose onto the ALT-5 static port.

10.1 Connection Diagram

The use of an external 1A fuse is recommended. Connect the supply terminals to your aircraft's power supply. The ALT-5 can be used on both 12V and 24V without the use of any pre-regulators. Ensure that the supply voltage will not drop below 8V during operation as this may result in incorrect readings.

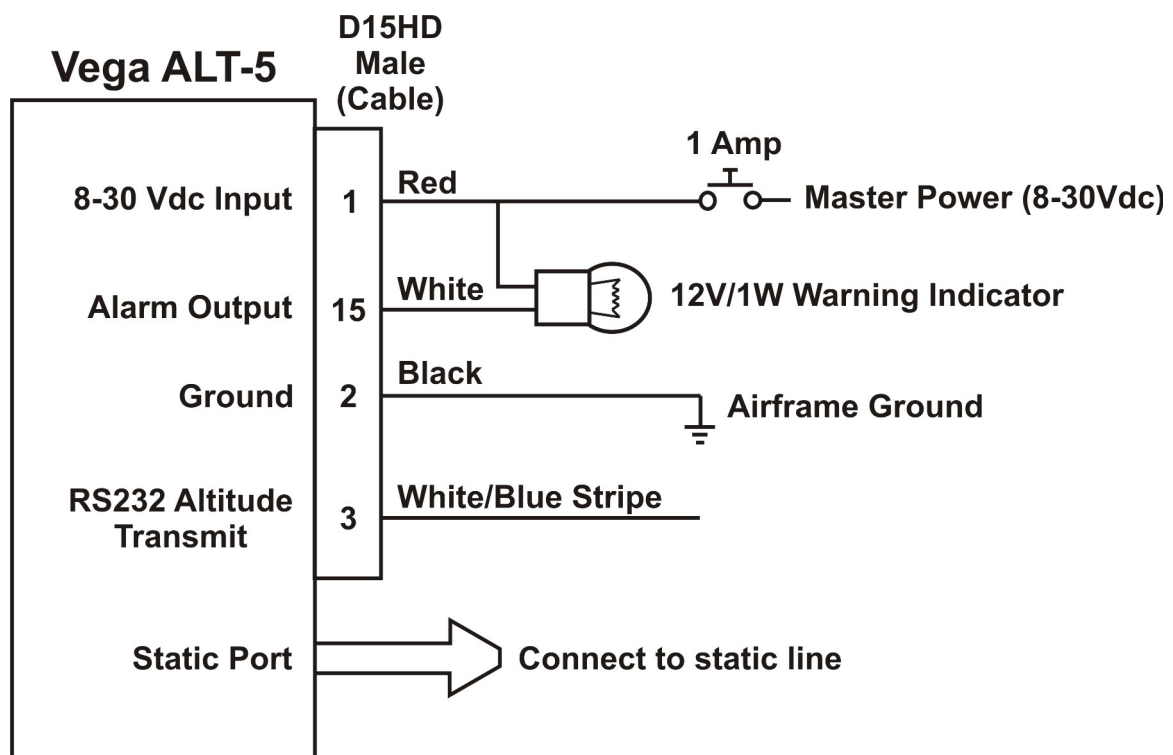

10.2 Pressure Port Dimensions (Brass)

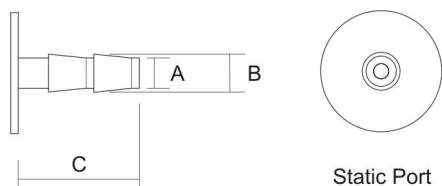

	Inches	Millimeters
A	0.157	4
B	0.197	5
C	0.63	16

10.3 Cable connections

Main connector (D15HD connector: Unit Female, Cable Male)

D15HD Pin	Color	Function
1	Red	8-30Vdc power via power switch / circuit breaker and fuse.
2	Black	Ground.
3	White/Blue Stripe	RS232 Transmit data (Firmware upgrading / RS232 Altitude output)
4	-	RS232 Receive data (Firmware upgrading)
15	White	Alarm Output (Open collector)

10.4 CNV-ALT (Serial altitude to parallel Gillham code converter)



The CNV-ALT accepts RS232 serial data from a compatible MGL Avionics instrument and produces parallel Gillham codes in a format compatible with mode C transponders. The ALT-5 serial protocol must be set to MGL Avionics.

11 Dimensions

Stratomaster Vega 2.25" (57mm) Dimensions

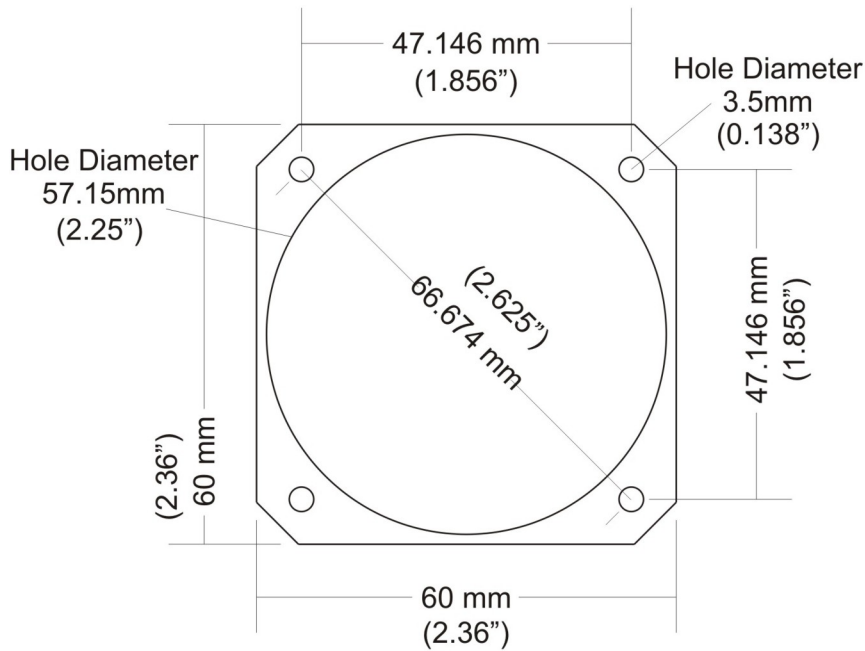

FRONT VIEW

3mm (0.118") mounting screws recommended

NOTE: 57.15mm (2.25") is a standard cutout, but due to manufacturing tolerances, 58mm (2.28") is found to be more desirable.

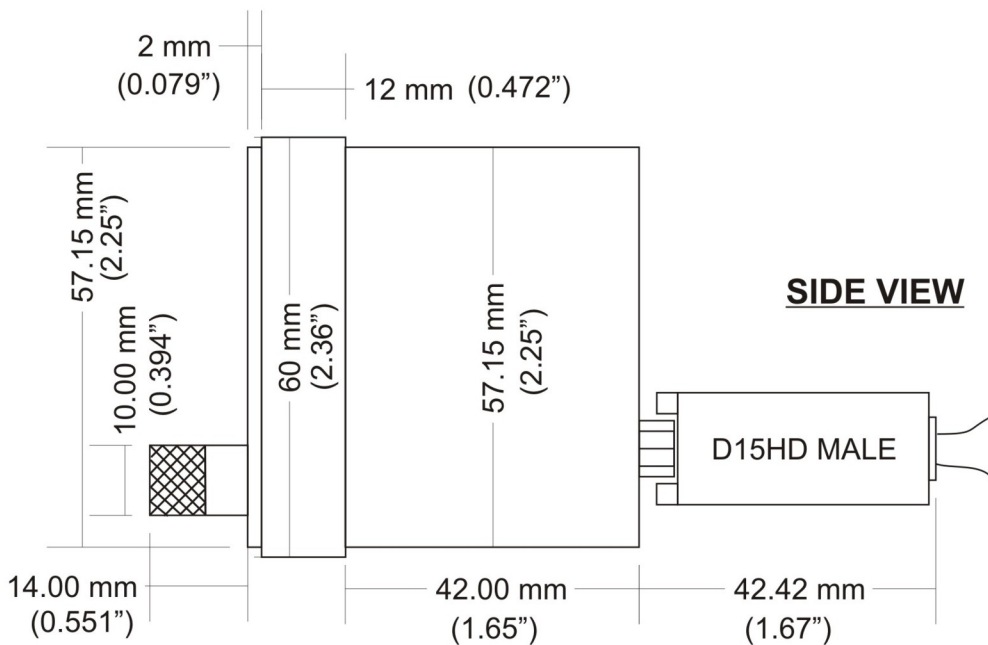

SIDE VIEW

12 Cleaning

The unit should not be cleaned with any abrasive substances. The screen is very sensitive to certain cleaning materials and should only be cleaned using a clean, damp cloth.

Warning: The ALT-5 is not waterproof, serious damage could occur if the unit is exposed to water and/or spray jets.

13 Warranty

This product carries a warranty for a period of one year from date of purchase against faulty workmanship or defective materials, provided there is no evidence that the unit has been mishandled or misused. Warranty is limited to the replacement of faulty components and includes the cost of labor. Shipping costs are for the account of the purchaser.

Note: Product warranty excludes damages caused by unprotected, unsuitable or incorrectly wired electrical supplies and or sensors, and damage caused by inductive loads.

14 Disclaimer

Operation of this instrument is the sole responsibility of the purchaser of the unit. The user must make themselves familiar with the operation of this instrument and the effect of any possible failure or malfunction.

This instrument is not certified by the FAA. Fitting of this instrument to certified aircraft is subject to the rules and conditions pertaining to such in your country. Please check with your local aviation authorities if in doubt. This instrument is intended for ultralight, microlight, home built and experimental aircraft. Operation of this instrument is the sole responsibility of the pilot in command (PIC) of the aircraft. This person must be proficient and carry a valid and relevant pilot's license. This person has to make themselves familiar with the operation of this instrument and the effect of any possible failure or malfunction. Under no circumstances does the manufacturer condone usage of this instrument for IFR flights.

IMPORTANT NOTICE:

You must make your own determination if the products sold by MGL Avionics are safe and effective for your intended applications. MGL Avionics makes no representations or warranties as to either the suitability of any of the products we sell as to your particular application or the compatibility of any of the products we sell with other products you may buy from us or anywhere else, and we disclaim any warranties or representations that may otherwise arise by law. Also, we offer no specific advice on how to install any of the products we sell other than passing along anything that may have been provided to us by the manufacturer or other issues. If you are in need of further information or guidance, please turn to the manufacturer, FAA Advisory Circulars and guidance materials, the Experimental Aircraft Association, or other reputable sources.

Continuing development sometimes necessitates specification changes without notice.

Other instruments in the *Stratomaster Vega* series

AHRS-1	Artificial Horizon and Magnetic Compass Indicator
AHRS-3	Self contained Artificial Horizon and Magnetic Compass Indicator
ALT-5	Altimeter and Vertical Speed Indicator (VSI)
ASI-4	Airspeed Indicator (ASI)
ASV-1	Altimeter, Airspeed (ASI) and Vertical Speed Indicator (VSI)
EMS-1	Engine Monitoring System
FF-4	Fuel Computer
INFO-1	Information Display (G-Force meter, UTC and Local Time, Slip Indicator, Outside Air Temperature (OAT), Battery Voltage, Current and charge display, Flight Timer & Flight Log, Stopwatch, Countdown Timer and Alarm)
MAG-1	Magnetic Compass Indicator
MAP-3	Manifold Pressure and RPM Indicator
RPM-1	Universal Engine / Rotor RPM Indicator
TC-4	4 Channel Thermocouple (EGT/CHT) Indicator
TP-3	4 Channel Universal Analog Input (Pressure/Temperature/Current/Volts) Indicator